

CREALITY

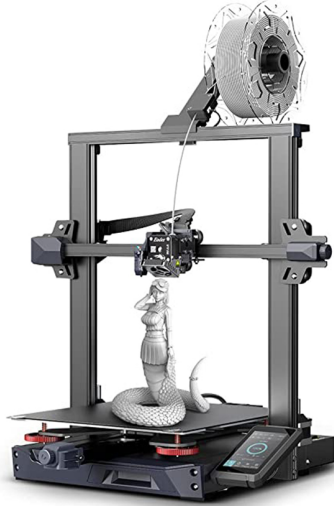

## Creality Ender 3 S1 Plus 3D Printer

[Read More](#)

**SKU:** 3DWG3C8Z145Z7

**Price:** 7,990.00 DH

**Stock:** outofstock

**Categories:** [FDM](#), [3D Printers](#)

**Tags:** [3d](#), [3d print](#), [3dprinter](#), [fdm](#), [Filament](#), [pla](#)

### Product Description

**Creality Official Ender 3 S1 PLUS Upgrade 3D Printer with CR Touch Auto-leveling Sprite Dual-Gear Extruder Double Z-axis Screw**

#### Core Features

**Build Volume Upgrade:** 300\*300\*300 mm, print larger-size models, meet more printing needs. **Hassle-free CR Touch Auto-leveling:** Quick leveling with automatic height compensation for 16 points on the heatbed. **"Sprite" Full-metal, Dual-gear Direct Extruder:** Good Filament Compatibility, brand new direct extruder, lightweight and powerful, ensures smooth feeding. **4.3-inch Touch Screen, Click to Control:** User-friendly UI supports 9 languages. Automatic dimming out in 3 minutes for energy saving. **Synchronized Dual Z-axes, High Precision Printing:** Dual Z-axes lead screws and dual motors for stable movement and quality printing.

**Quick Assembly, easy to handle:** 96% pre-installed, 6-step assembly, easy to use.

# Ender-3 S1 Plus 3D Printer

Larger Build Volume, More Creative Possibilities

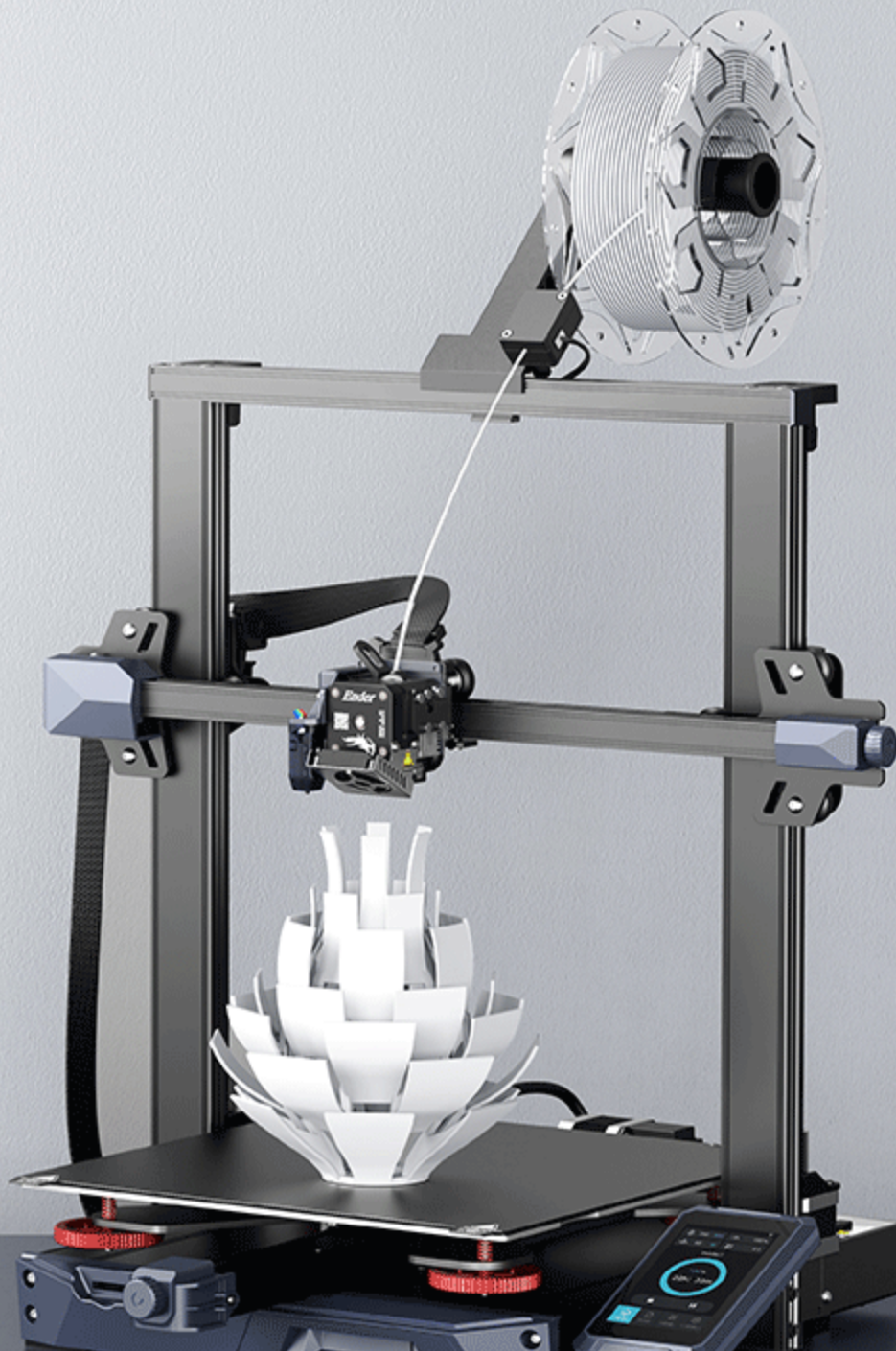



Build Volume  
300\*300\*300 mm



CR Touch  
Auto-leveling



"Sprite"  
Direct Extruder



4.3-inch  
Touch Screen



Dual  
Z-axes



Quick  
Assembly

## Build Volume Upgrade 300\*300\*300 mm

Print larger-size models, meet more  
printing needs.

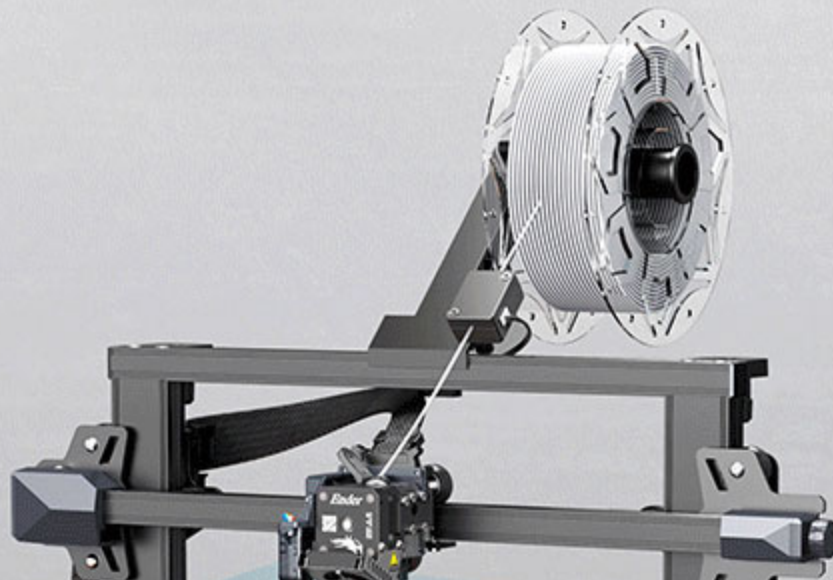

# "Sprite" Dual-gear Direct Extruder Good Filament Compatibility

Brand new direct extruder,  
lightweight and powerful, ensures  
smooth feeding.

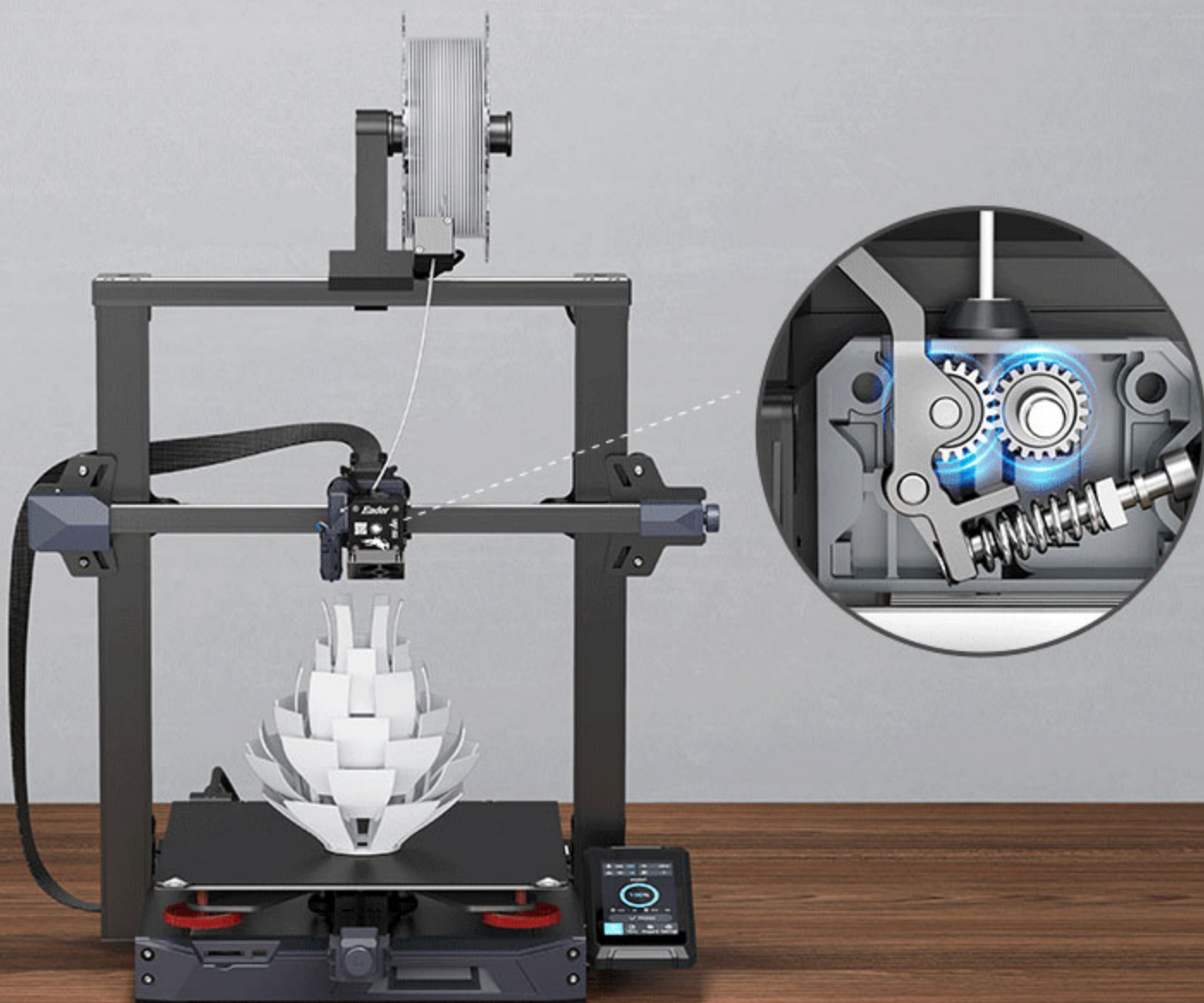

# Hassle-free CR Touch Auto-leveling

Quick leveling with automatic height compensation for 16 points on the heatbed.

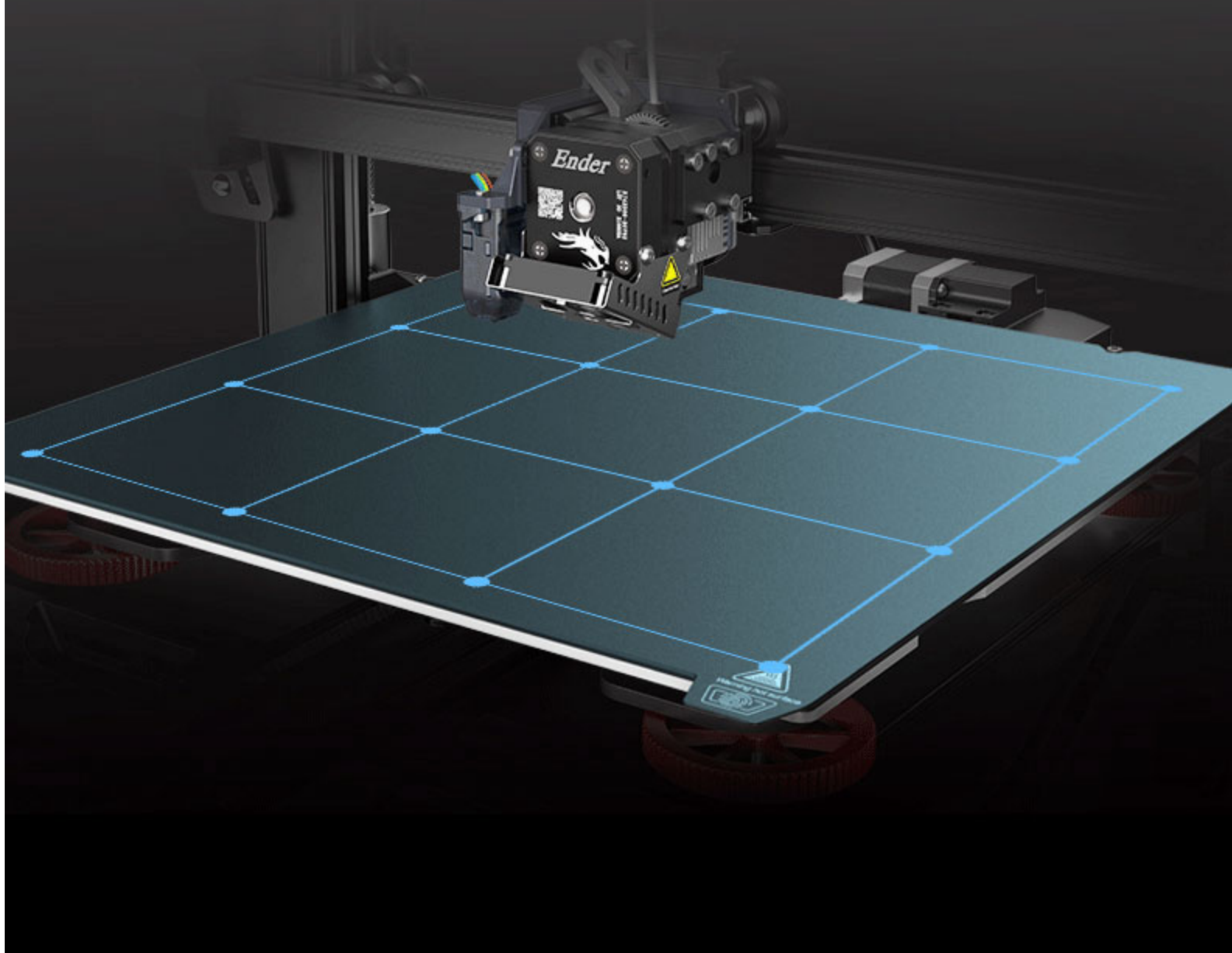

## 4.3-inch Touch Screen Click to Control

User-friendly UI supports 9 languages.  
Automatic dimming out in 3 minutes  
for energy saving.



# Synchronized Dual Z-axes High Precision Printing

Dual Z-axis lead screws and dual motors, stable movement, higher printing quality.

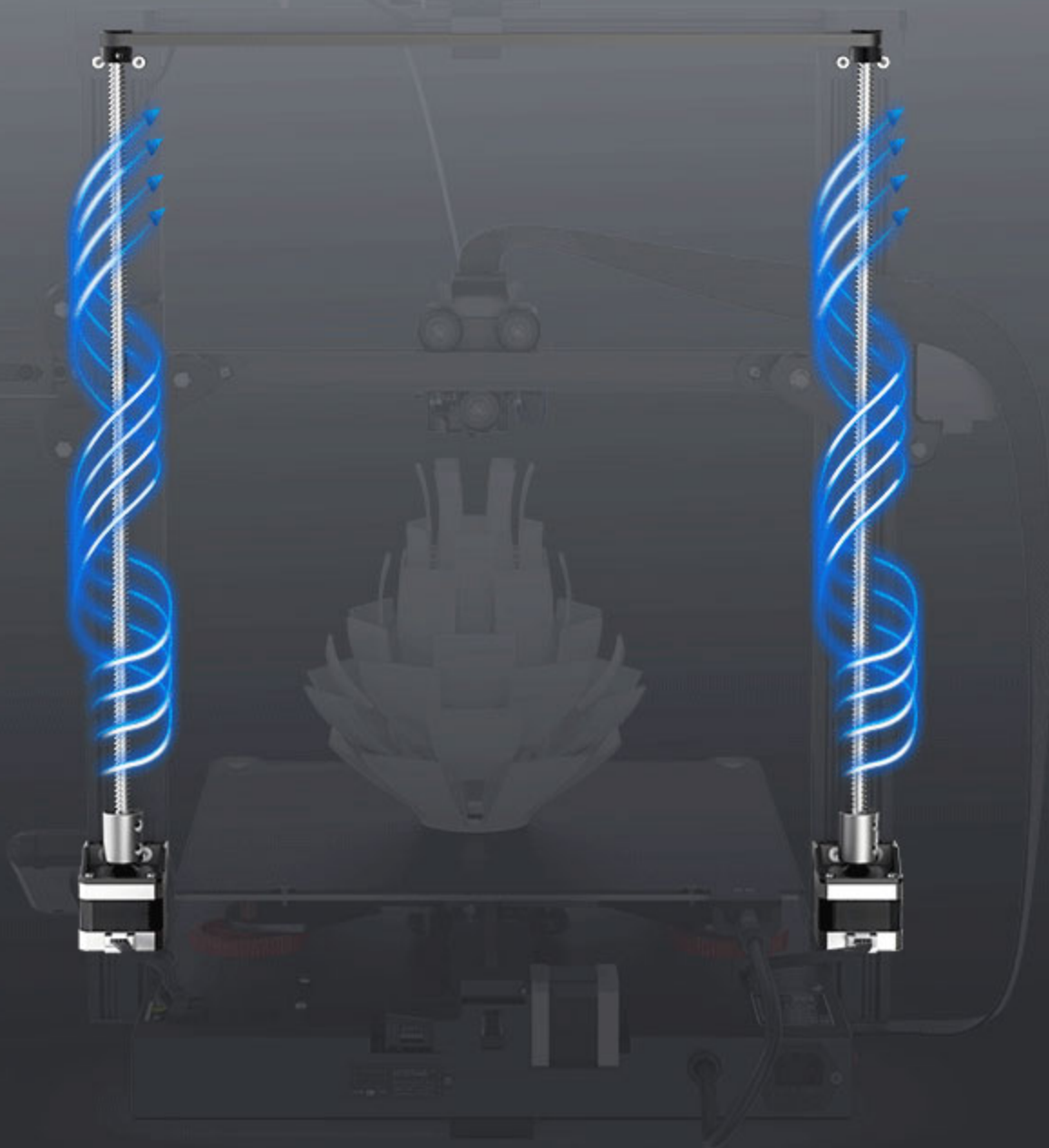

# Quick Assembly Easy to Handle

96% pre-installed, 6-step assembly,  
easy to use.





## / Product Advantages



### Build Volume Upgrade - 300\*300\*300 mm

Print larger-size models, meet more printing needs.



### "Sprite" Full-metal Dual-gear Direct Extruder

Brand new direct extruder, lightweight and powerful, ensures smooth feeding.



### Synchronized Dual Z-axes

Dual Z-axis lead screws and dual motors, stable movement, higher printing quality.



### Hassle-free CR Touch Auto-leveling

Quick leveling with automatic height compensation for 16 points on the heatbed.



### 4.3-inch Touch Screen, Click to Control

User-friendly UI supports 9 languages. Automatic power off in 3 minutes for energy saving.





### Quick Assembly, Easy to Handle

96% pre-installed, 6-step assembly, easy to use.

## / Specifications

Molding Technology	FDM	Build Surface	Spring steel PC magnetic build plate
Build Volume	300*300*300mm	Extruder	"Sprite" Full-metal dual-gear direct extruder
Machine Dimension	557*535*655mm	Extrusion Force	80N
Package Dimension	625*590*230mm	Leveling Mode	Auto-leveling with CR-Touch
Net Weight	10.25kg	Display	4.3" color touch screen
Gross Weight	13.4kg	Mainboard	32-bit silent mainboard
Printing Speed	maximum 100 mm/s	Resume Printing	Yes
Printing Precision	100mm±0.2mm	Filament Sensor	Yes
Layer Height	0.1-0.4mm	Rated Voltage	100-120V, 220-240V, 50/60Hz
Filament Diameter	1.75 mm	Rated Power	350W/24V
Nozzle Quantity	1	Slicing Software	Creality Slicer/Cura/Repetier-Host/Simplify3D
Nozzle Diameter	0.4 mm	Data Transmission Method	Type-C USB/ SD card
Nozzle Temperature	up to 260°C	3D File Format	STL/OBJ/AMF
Heat Bed Temperature	up to 100°C	Supported Filament	PLA/ABS/TPU/PETG
Supported Language	Chinese, English, Spanish, German, French, Portuguese, Italian, Russian and Turkish		

<b>Product Image</b>	<b>Ender-3 S1</b>  <b>\$399</b>	<b>Ender-3 S1 Pro</b>  <b>\$479</b>
Build Volume	220*220*270 mm	220*220*270 mm
Machine Dimension	487*453*622 mm	490*455*625 mm
Package Dimension	535*510*255 mm	510*510*280 mm
Net Weight	9.1 kg	8.7 kg
Gross Weight	11.2 kg	11.1 kg
Layer Height	0.05-0.4 mm	0.05-0.4 mm
Supported Filaments	PLA/TPU/PETG/ABS	PLA/ABS/Wood/TPU/...
Data Transmission Method	Type-C/SD Card	Type-C/SD Card
Resume Printing	√	√
Filament Sensor	√	√
Dual Z-Axis	√	√
Leveling Mode	CR Touch Auto-leveling	CR Touch Auto-leveling
Mainboard	32-bit Silent Mainboard	32-bit Silent Mainboard
Build Surface	PC Spring Steel Magnetic Build Plate	PEI Spring Steel Magnetic Build Plate
Extruder	"Sprite" Dual-gear	"Sprite" Dual-gear

# COMPANY INTRODUCTION

---

## Shenzhen Creality 3D Technology Co., Ltd.

Creality 3D is an internationally renowned 3D printer manufacturer, national high-tech enterprise, and a pioneer in the R&D and mass production of FDM and resin 3D printers in China. Our company has been committed to applying 3D printers into market, delivering efficient and cost-effective integrated 3D printing solutions for individuals, families, schools and enterprises.

Headquartered in Shenzhen, Creality 3D has branches in Beijing, Shanghai and Wuhan, and cooperates with colleges and universities to build an industry-university-research teaching and internship base. We have a complete set of R&D, manufacturing and after-sales service system and strong technological strength. With a total area of 30,000m<sup>2</sup>, a team of over 1,000 employees, and monthly production capacity of over 800,000 units, Creality 3D prides itself on its large-scale R&D center and 3D printing laboratories and Creality research institute. Coupled with modern production lines working for 24 hours nonstop and demanding quality control system, the excellent